



MATLAB EXPO 2017

从创意到实现 —— IoT 时代的智能系统

陈炜博士
张延亮博士
陈建平

亚太区大学计划高级经理，ARM研究院
首席科学家，松山湖国际机器人研究院
高级应用工程师，MathWorks 中国

智能系统无处不在

- 汽车工业
- 无人机
- 医药
- 人形机器人
- 农业
- 家用电器
- 玩具
- 消费电子
- 3D 打印
- 仓储
- 物流
- ...

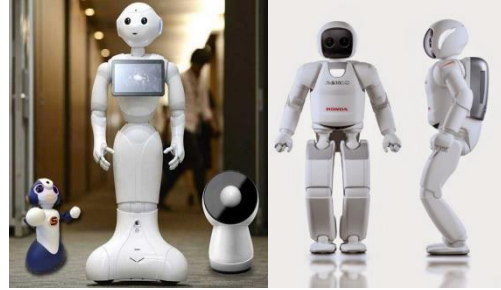

智能系统的架构

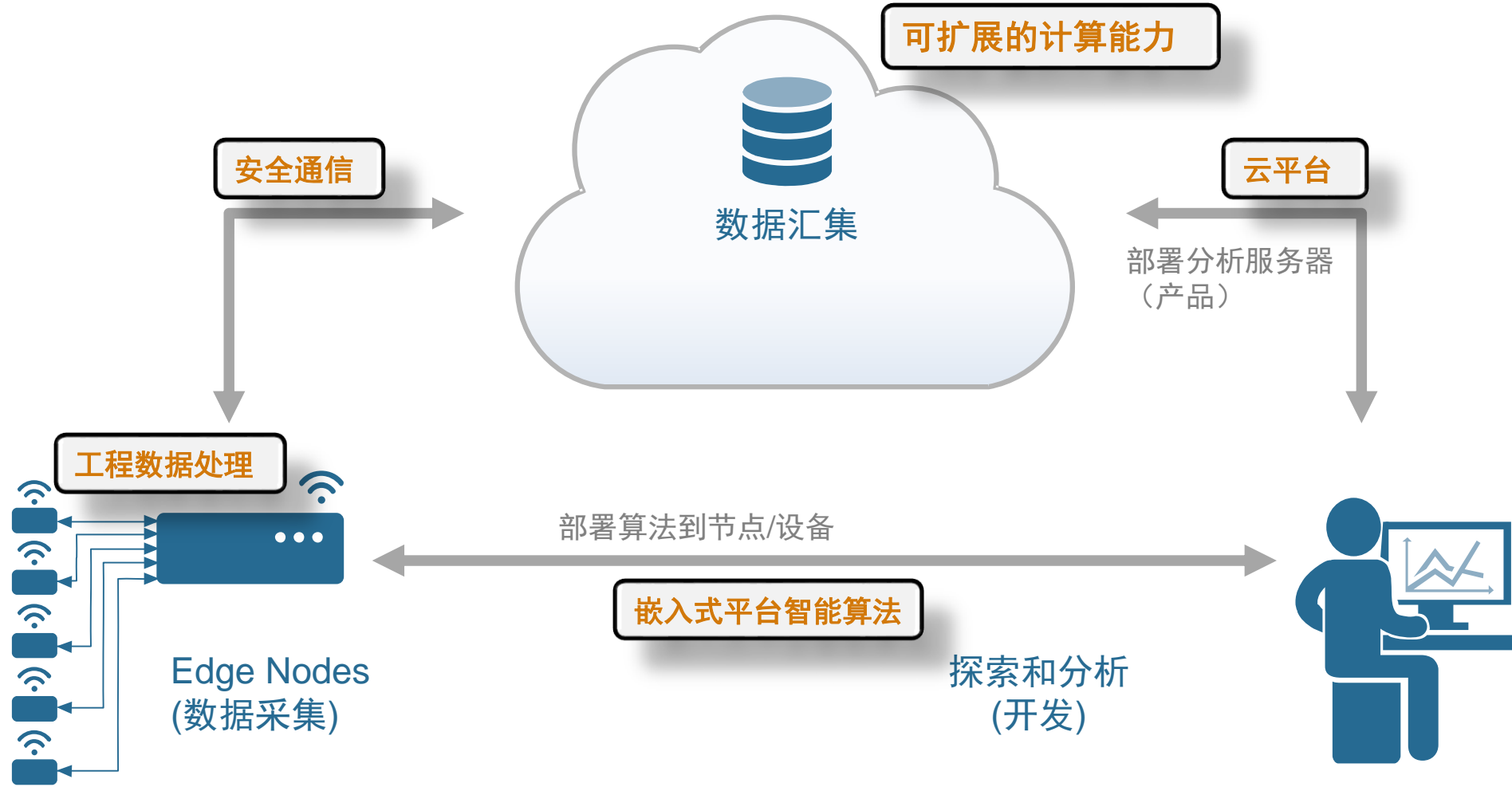

智能系统的挑战

快速迭代!

- 领域相关的算法
- 通信系统开发和和数据安全
- 低功耗嵌入式系统
- 智能算法开发和部署

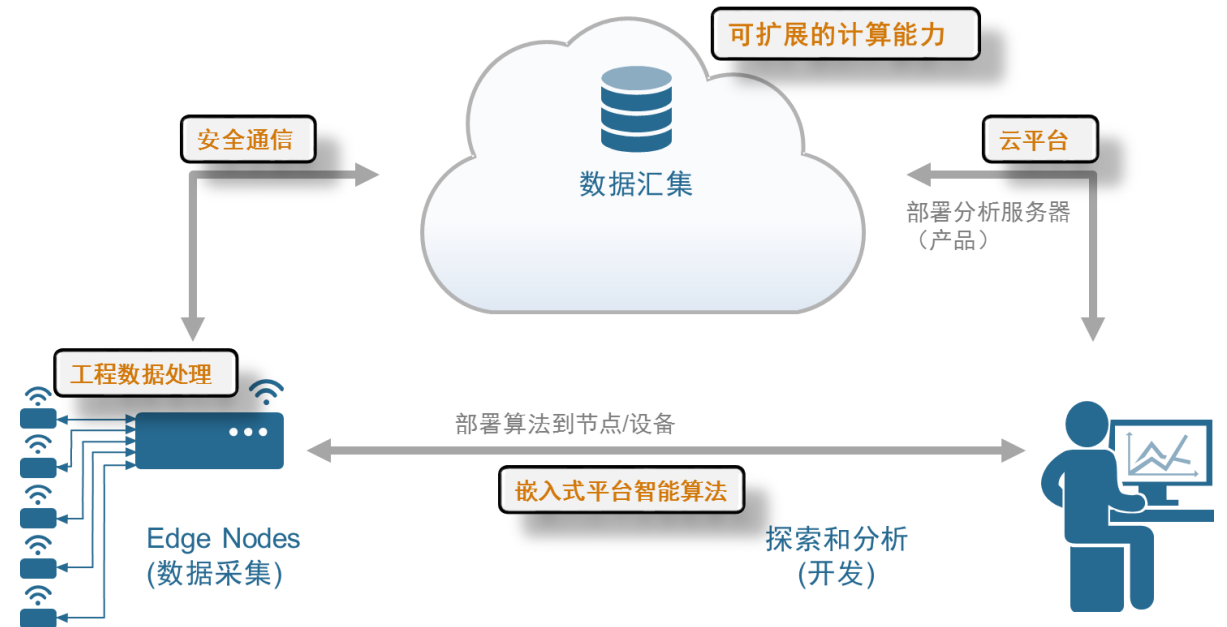

基于 ARM 的智能设备开发

—— 安全通信和嵌入式算法

芯片级的安全解决方案

ARMv8 development timeline

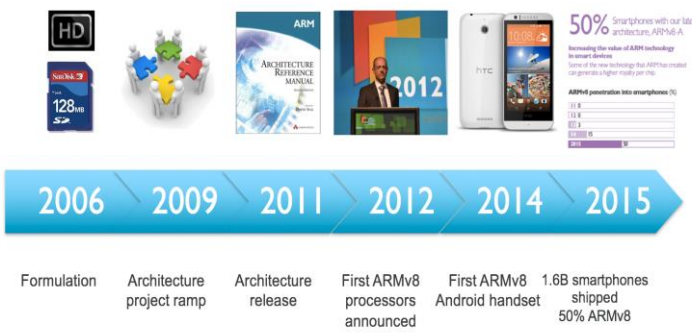

8 Confidential ©ARM 2017

- 安全硬件系统架构
- 可信固件
- TEE
- 可信升级服务
- 安全协议

- Accelerate
- CoDesigned with Distributed Application
- CoDesigned with Ecosystem
- Co-Design with (Constrained) Environment
- Challenge & Opportunity for PRC Ecosystem

TrustZone for ARMv8-M: time to market & secure

ARMv8-M, The New Microcontroller Architecture With TrustZone Security Built-in

21 Hacked Cameras, DVRs Powered Today's Massive Internet Outage

A massive and sustained Internet attack that has caused outages and network congestion today for a large number of Web sites was launched with the help of hacked "Internet of Things" (IoT) devices, such as CCTV video cameras and digital video recorders, new data suggests.

ARM Goes for IoT with the Cortex-M33 and Cortex-M23 Cores

Going after IoT with ARMv8-M and TrustZone...



9 Confidential ©ARM 2017

PSA is defining a framework and core security functions

Defines the TCB and various levels of isolation

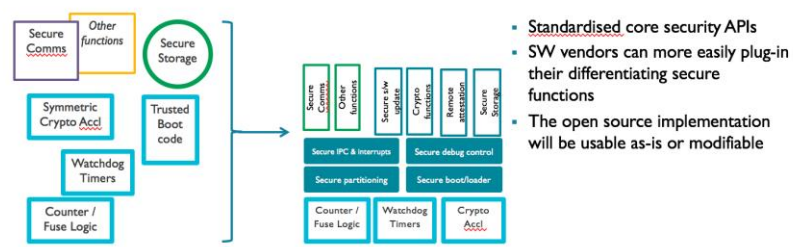

Increases the value of the SoC to ODM/OEMs because it has known security functionality and makes life easier for 3rd party SW vendors

13 ARM Confidential ©ARM 2017

MATLAB 和 Simulink 对 ARM Cortex-A 的支持

- 产生优化的可跟踪 C 代码
- 支持调用 Ne10 库，针对 ARM[®] Cortex[®]-A 的目标优化
- 通过系统对象和 Simulink 模块优化 DSP 库
-

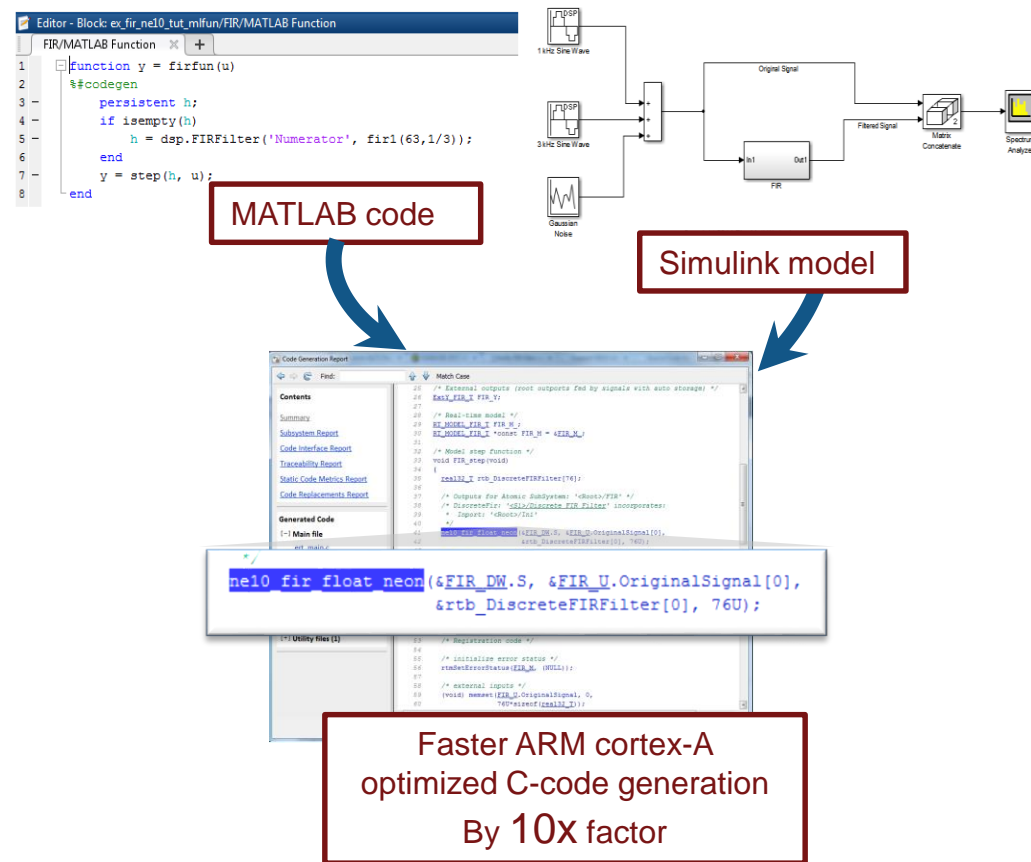

Demo

—— 基于 ARM 的智能心电图监控设备

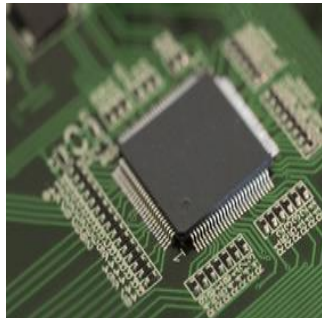
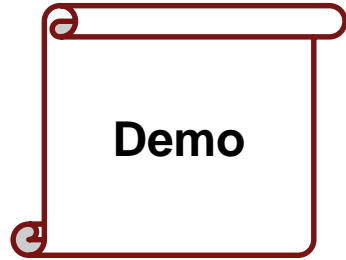

通过 ARM Cortex-A开发板 BeagleBone Black (BBB) s 实时采集流数据 (ECG)

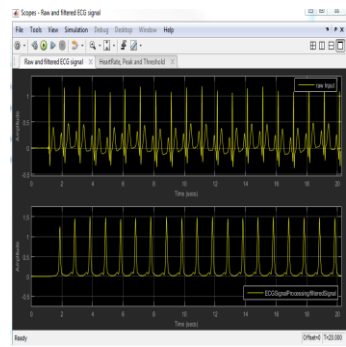

流式算法：
实时滤波，采样率调整，检测，分类

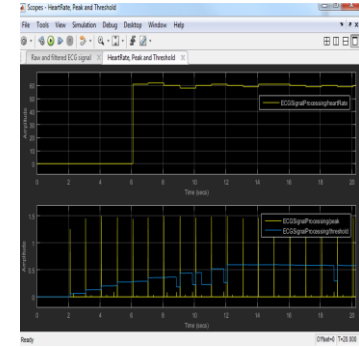

原形：
使用外部模式协同测试算法

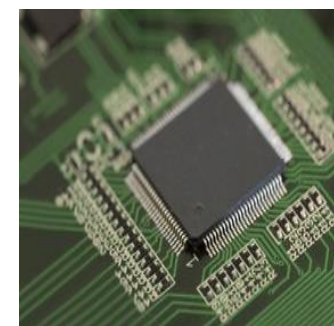

实现：
自动生成和部署算法到 ARM Cortex-A BBB 开发板之中

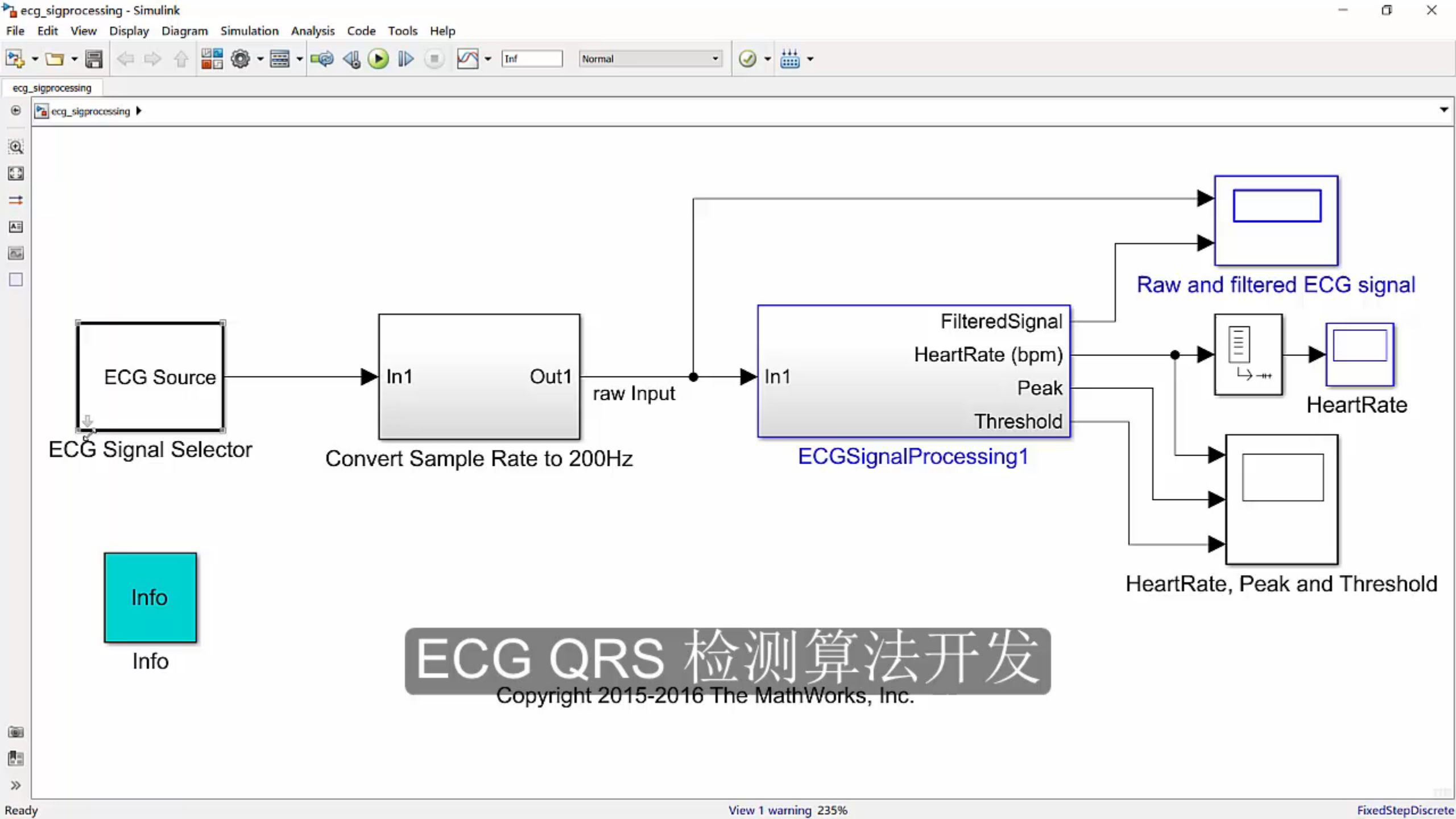

ECG QRS 检测算法开发

Copyright 2015-2016 The MathWorks, Inc.

从算法到系统原型

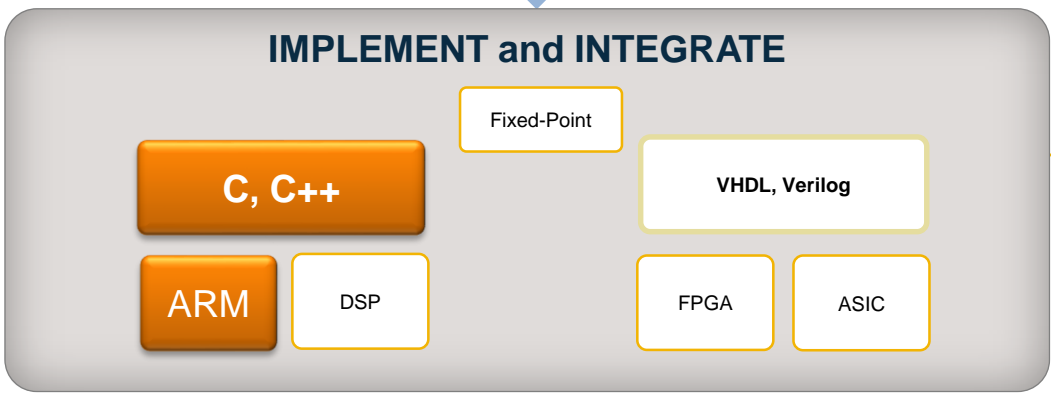
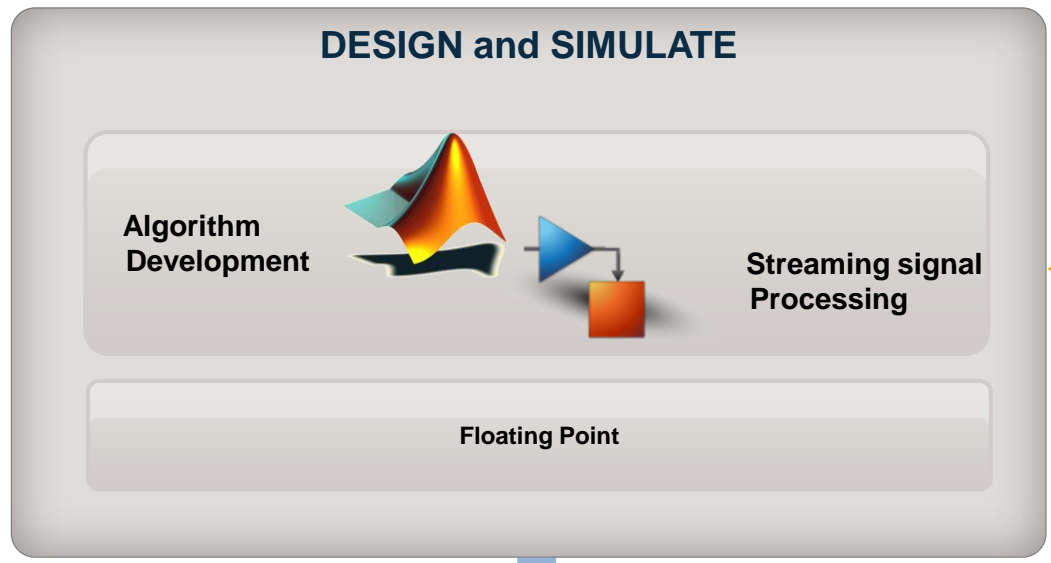

Quick design and faster simulation for real-time DSP systems

- Streaming Signal Processing in MATLAB
- Signal Processing in Simulink
- Single and Multirate FIR/IIR Filter Design, and Adaptive Filters
- Signal Scopes, Analyzers, and Measurements
- Real-Time Multichannel Audio Processing and I/O

Rapid prototyping with streamline test and verification:

- C and C++ Code Generation for Desktop Acceleration and Deployment
- Implementation and Integration for FPGA, ASIC, DSP and ARM

基于 ARM 的智能心律监控设备 Solution

- 基于模型的设计流程
- 可执行的需求和仿真
预处理 & ECG 信号的检测
- 代码生成
产生基于 ARM Cortex-A
的优化后的 PIL 模块
- 验证
在 BeagleBone Black 开发
板中实时运行

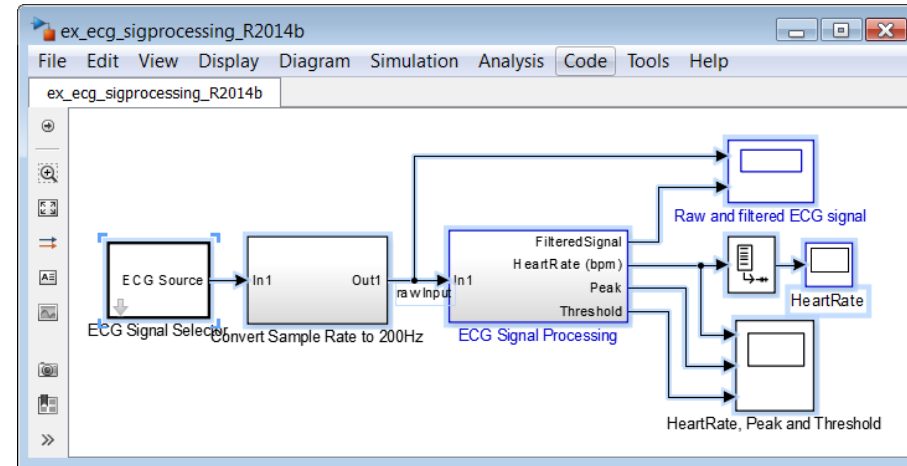

| Contents | Code |
|--|--|
| Summary | 157 <code>real_T y;</code> |
| Subsystem Report | 158 <code>int32_T i;</code> |
| Code Interface Report | 159 <code>int16_T RRSum;</code> |
| Traceability Report | 160 <code>uint32_T tmp;</code> |
| Static Code Metrics Report | 161 |
| Code Replacements Report | 162 <code>/* DiscreteFir: '<S1>/Bandpass_Filter' incorporates:</code> |
| | 163 <code>* Inport: '<Root>/In1'</code> |
| | 164 <code>*/</code> |
| | 165 <code>ne10_fir_float_neon(&ECGSignalProcessingSubsystem_DN.S,</code> |
| | 166 <code>&ECGSignalProcessingSubsystem_U.rawInput[0],</code> |
| | 167 <code>&ECGSignalProcessingSubsystem_B.BandpassFilter[0], 50U);</code> |
| | 168 |
| | 169 <code>/* DiscreteFir: '<S1>/derivative' */</code> |
| | 170 <code>ne10_fir_float_neon(&ECGSignalProcessingSubsystem_DN.S_c,</code> |
| | 171 <code>&ECGSignalProcessingSubsystem_B.BandpassFilter[0],</code> |
| | 172 <code>&ECGSignalProcessingSubsystem_B.Abs[0], 50U);</code> |
| | 173 |
| | 174 <code>/* Abs: '<S1>/Abs' */</code> |
| | 175 <code>for (i = 0; i < 50; i++) {</code> |
| | 176 <code>ECGSignalProcessingSubsystem_B.Abs[i] = (real32_T) fabs</code> |
| | 177 <code>(ECGSignalProcessingSubsystem_B.Abs[i]);</code> |
| | 178 |

终端和云端的智能算法

—— 基于工程数据的算法

**MATLAB 数据分析同时应用于
商业数据和工程数据**

商业和交易数据

数据仓库

- Databases (SQL)
- NoSQL
- Hadoop

文件 I/O

- Text
- Spreadsheet
- XML

网络数据

- RESTful
- JSON
- HTML
- Mapping
- Financial datafeeds

工程和科学数据

文件 I/O

- Text
- Spreadsheet
- XML
- CDF/HDF
- Image
- Audio
- Video
- Geospatial

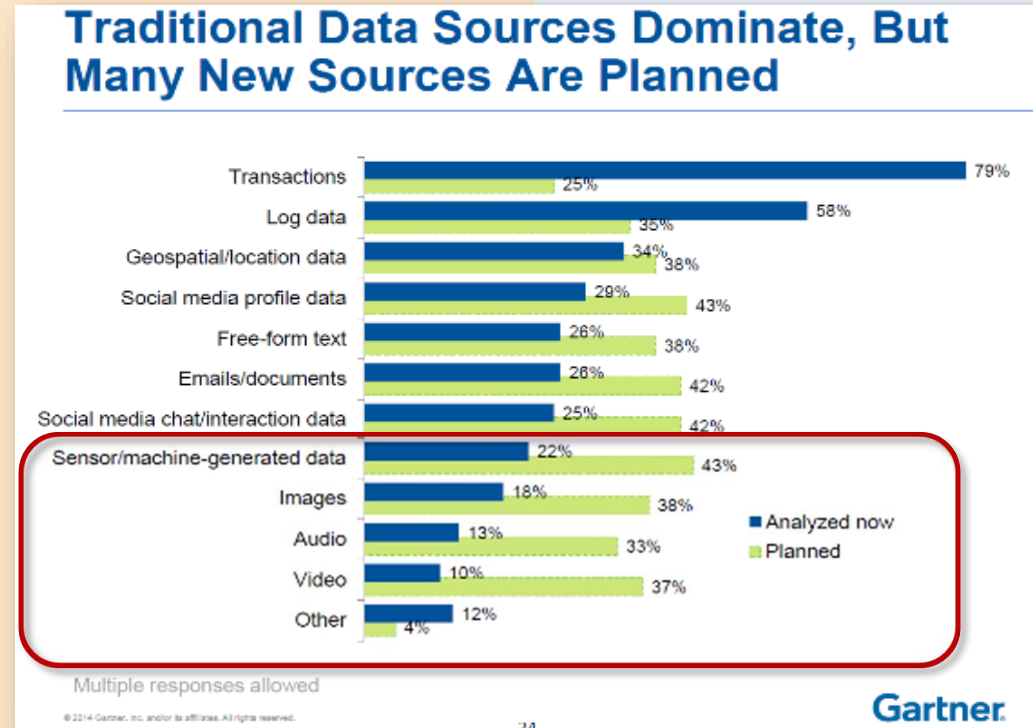
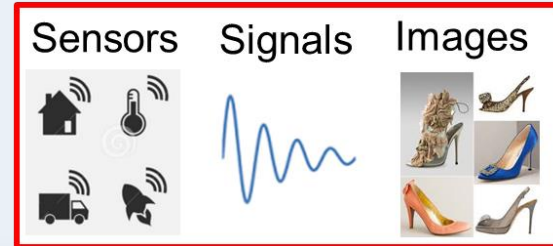

通信协议

- CAN (Controller Area Network)
- DDS (Data Distribution Service)
- OPC (OLE for Process Control)
- XCP (eXplicit Control Protocol)

实时数据

- Sensors
- GPS
- Instrumentation
- Cameras
- Communication systems
- Machines (embedded systems)

MATLAB 智能算法流程

| 1 | 2 | 3 | 4 |
|----------------------|--------|--------|---------|
| Date | CAPITL | CENTRL | DUNWOOD |
| 01-Jan-2004 00:00:00 | 1015 | 1651 | 618 |
| 01-Jan-2004 01:00:00 | 927 | 1562 | 568 |
| 01-Jan-2004 02:00:00 | 891 | 1507 | 541 |
| 01-Jan-2004 03:00:00 | NaN | 1440 | 517 |
| 01-Jan-2004 04:00:00 | NaN | 1434 | 499 |
| 01-Jan-2004 05:00:00 | NaN | 1449 | 496 |
| 01-Jan-2004 06:00:00 | NaN | 1490 | 524 |
| 01-Jan-2004 07:00:00 | NaN | 1525 | 526 |
| 01-Jan-2004 08:00:00 | 960 | 1529 | 518 |
| 01-Jan-2004 09:00:00 | 1046 | 1628 | 541 |
| 01-Jan-2004 10:00:00 | 1111 | 1706 | 570 |

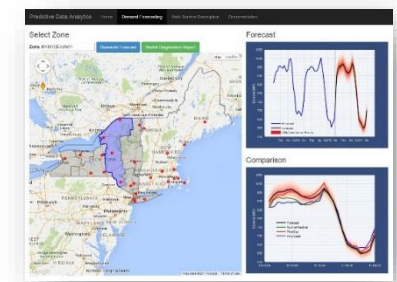
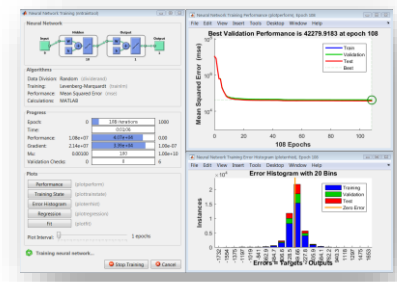
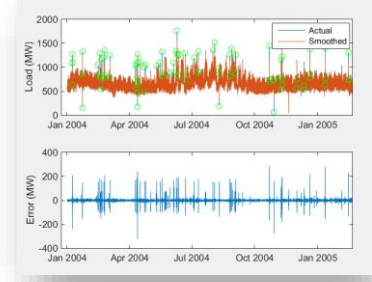

数据访问和探索

预处理

预测算法

系统集成

MATLAB Analytics work with business and engineering data

MATLAB lets engineers do Data Science themselves

MATLAB Analytics run anywhere

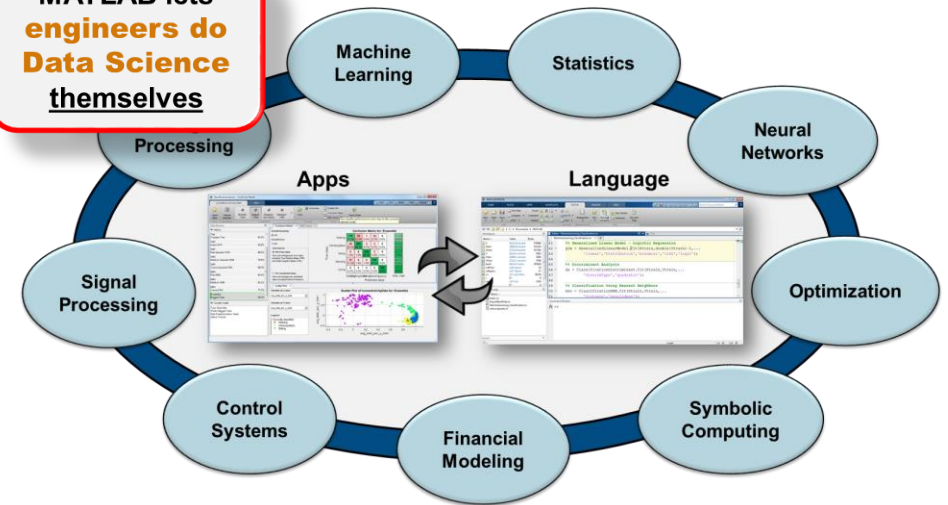

- Repositories**
 - Databases (SQL)
 - NoSQL
 - Hadoop
- File I/O**
 - Text
 - Spreadsheet
 - XML
- Web Sources**
 - RESTful
 - JSON
 - HTML
 - Mapping
 - Financial datafeeds
- Communication Protocols**
 - CAN (Controller Area Network)
 - DDS (Data Distribution Service)
 - OPC (OLE for Process Control)
 - XCP (eXplicit Control Protocol)
- Real-Time Sources**
 - Sensors
 - GPS
 - Instrumentation
 - Cameras
 - Communication systems
 - Machines (embedded systems)

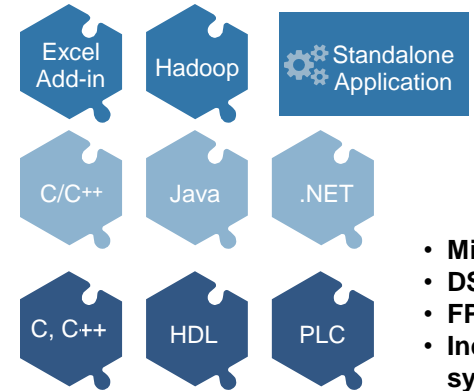

- Microcontrollers
- DSP chips
- FPGAs
- Industrial automation systems

MATLAB Analytics Scale

- Cloud
- Web
- Cluster
- GPU
- Desktop
- Mobile

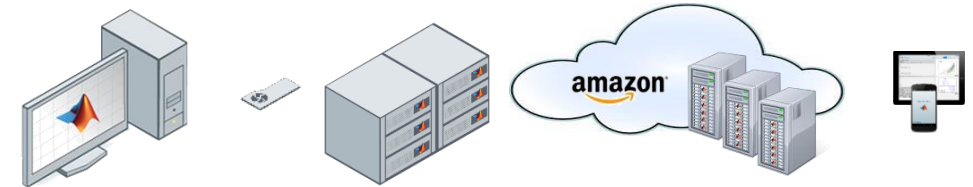

Demo

— 人体动作识别

Demo

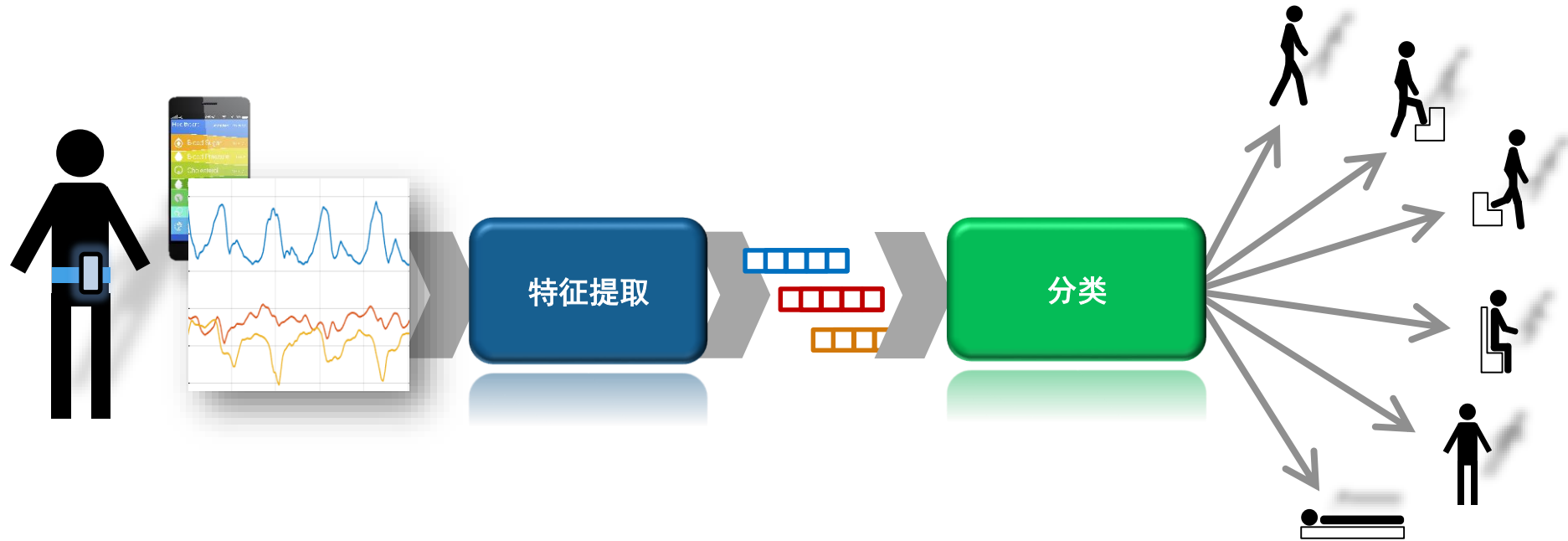
**Dataset courtesy of:**

Davide Anguita, Alessandro Ghio, Luca Oneto, Xavier Parra and Jorge L. Reyes-Ortiz.

Human Activity Recognition on Smartphones using a Multiclass Hardware-Friendly Support Vector Machine.

International Workshop of Ambient Assisted Living (IWAAL 2012). Vitoria-Gasteiz, Spain. Dec 2012

<http://archive.ics.uci.edu/ml/datasets/Human+Activity+Recognition+Using+Smartphones>

Human Activity Detection

文件(F) 编辑(E) 查看(V) 插入(I) 工具(T) 桌面(D) 窗口(W) 帮助(H)

新建 脚本

命令窗口

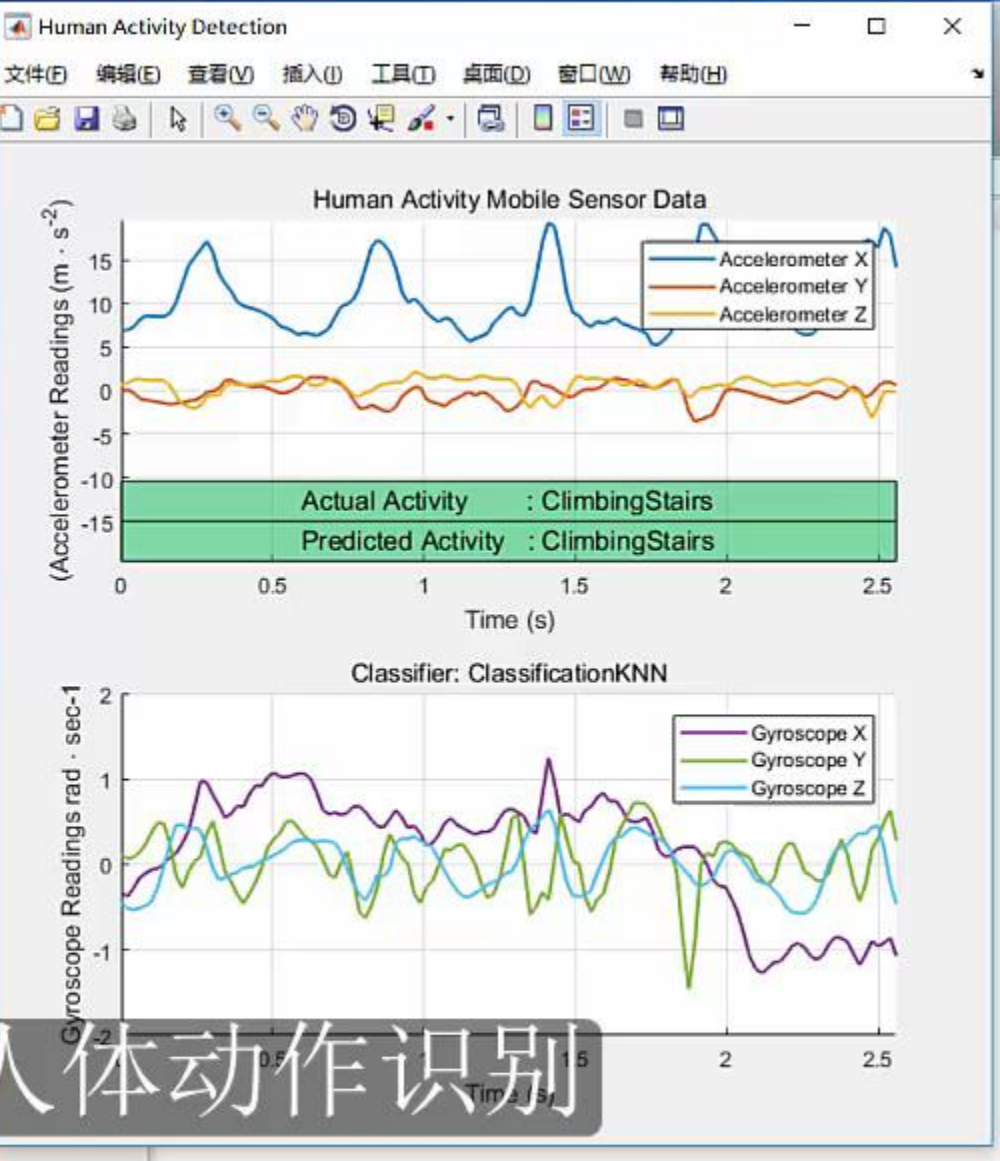
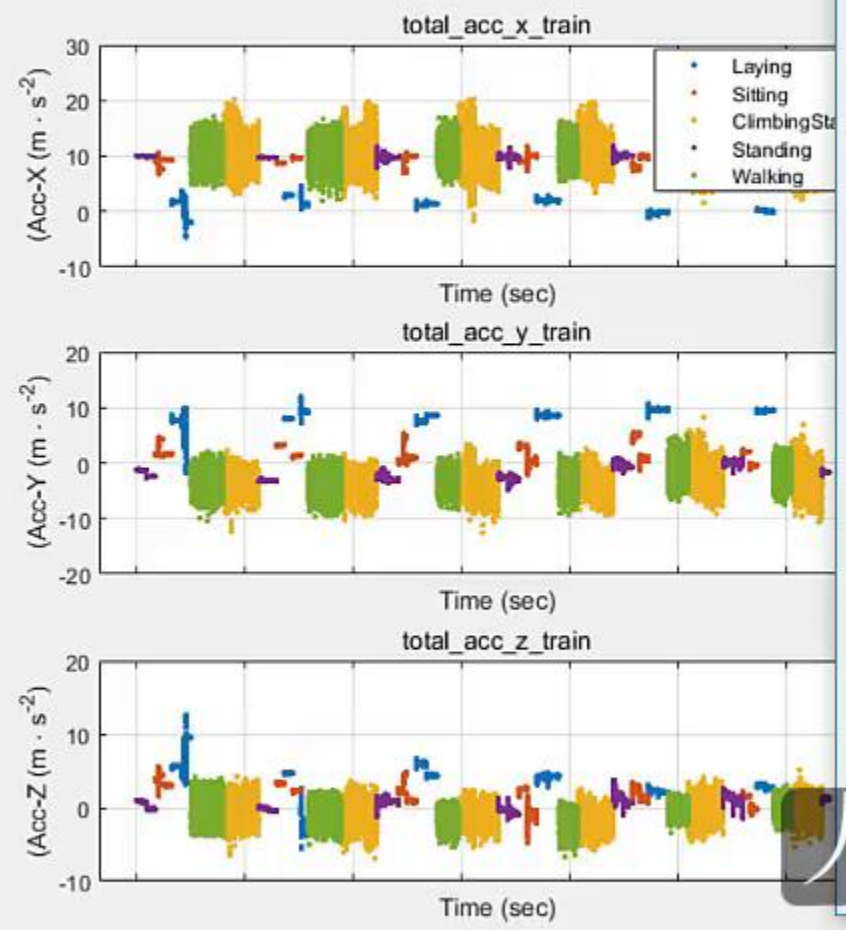

人体动作识别

动作识别 Solution

- 基于 App 的快速机器算法
- 65 行核心代码实现特征提取、分类算法
- 支持云端的代码部署
- 支持基于嵌入式系统的 C 代码生成

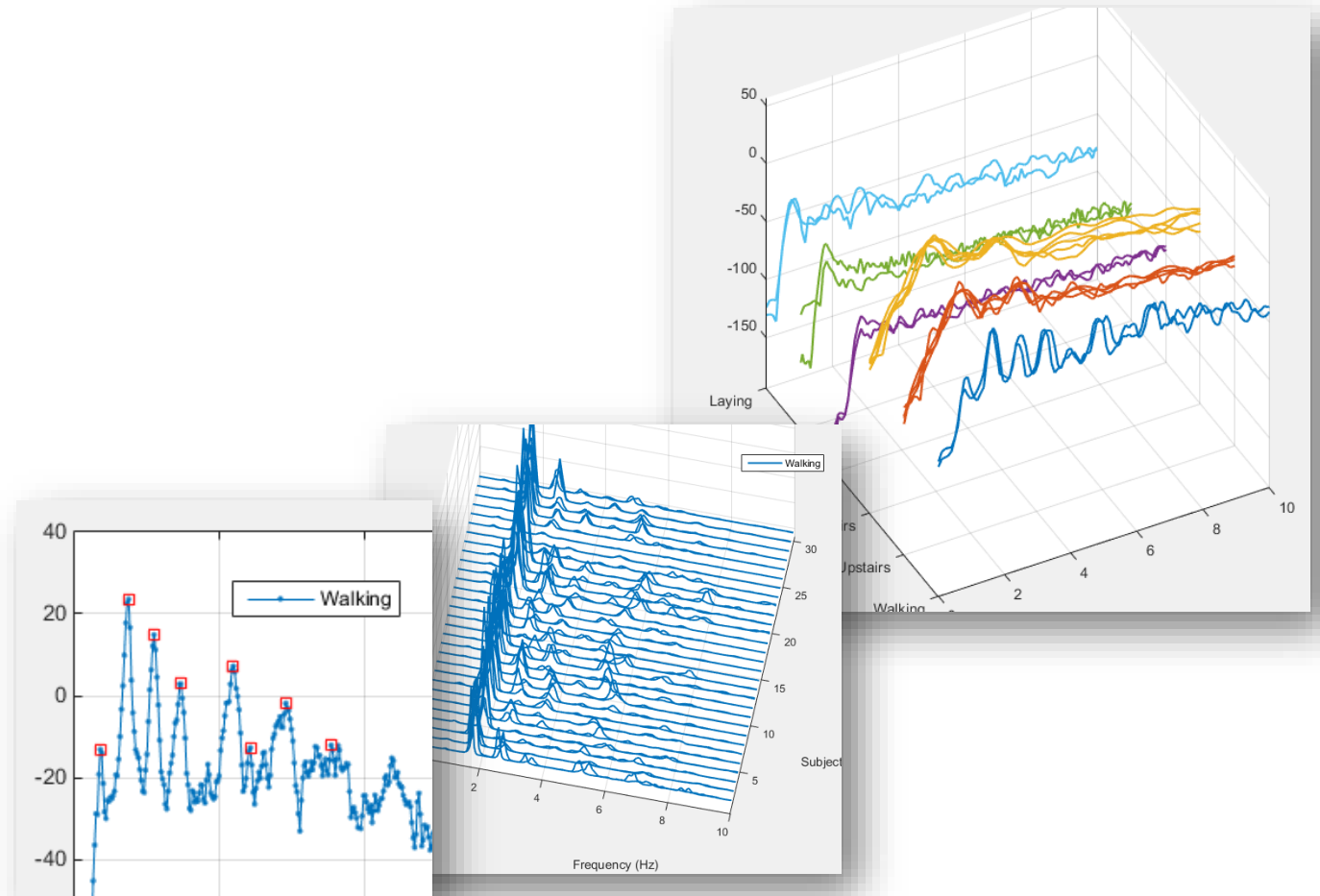

大数据扩展和应用发布

—— 一键式应用部署

大数据应用

本地磁盘
共享目录
数据库

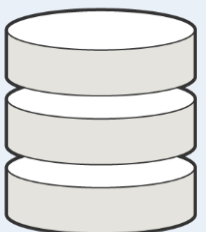

- Tall arrays
MATLAB
- 几百个内建函数
MATLAB
统计和机器学习工具箱
- 并行执行
并行计算工具箱

在计算集群中并行执行
MATLAB 分布式计算服务器

计算集群



Spark + Hadoop

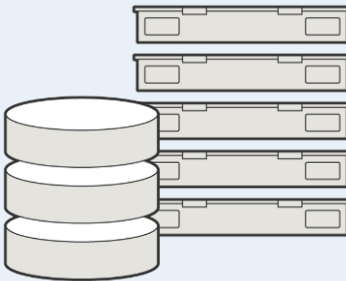

- 在 Spark 集群中并行执行
MATLAB 分布式计算服务器
- 发布 MATLAB 应用，并部署到 Spark 集群之中
MATLAB 编译器



MATLAB 发布和部署

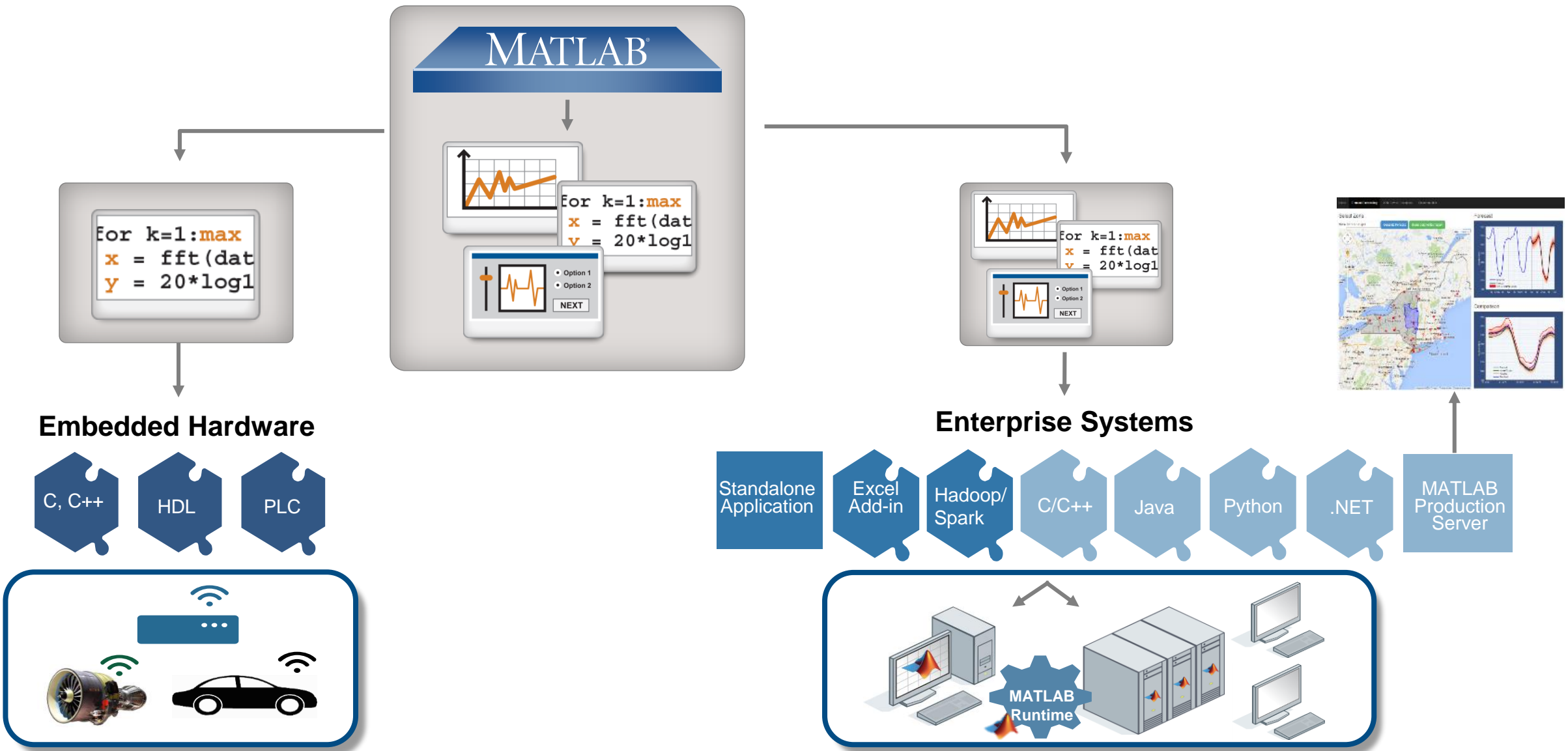

Embedded Hardware



Enterprise Systems

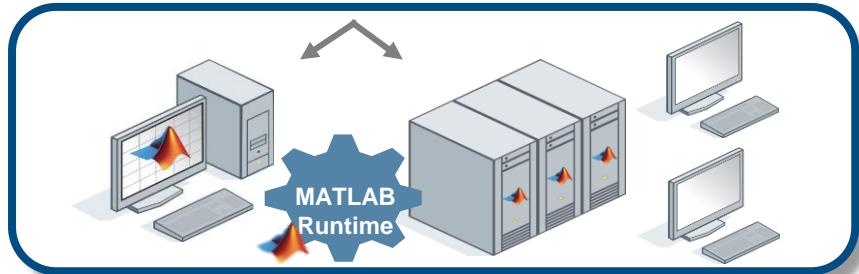
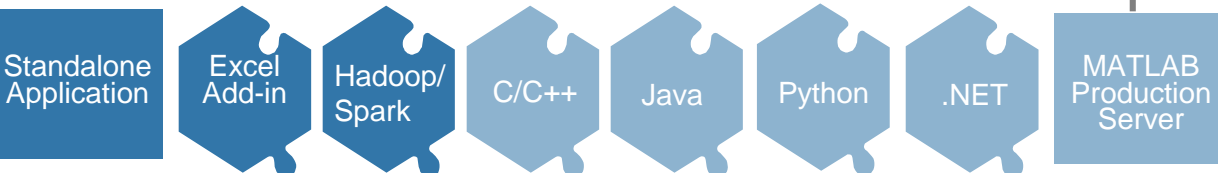

基于公有云的部署

ThingSpeak Channels Apps Blog Support Sign In Sign Up

Billions and Billions

The open data platform for the Internet of Things

[Get Started](#) [Contact Us](#)

Collect
Send sensor data to the cloud.

Analyze
Analyze and visualize your data.

Act
Trigger a reaction.

```

% Download the tide data using a custom function
[tideTime,tideRangemm] = readAllMyTideData();

% Distance from the gauge to water depth from the mud
% Measured distance from the gauge to the mud.
depthMm = (tideRangemm - tideRangemm) / 25.4 / 12;

% Unique tide times
[uniqueTimeIndex] = unique(tideTime);

% Sort by time
sort(uniqueTimeIndex);

% Depth in feet
depthFeet = depthMm * 30.48;

% (could also use movmedian)
smoothDepthFeet = movmedian(depthFeet,121,2);

% Plot
plot(smoothDepthFeet,'r');
hold on;
plot(depthFeet,'b');

```

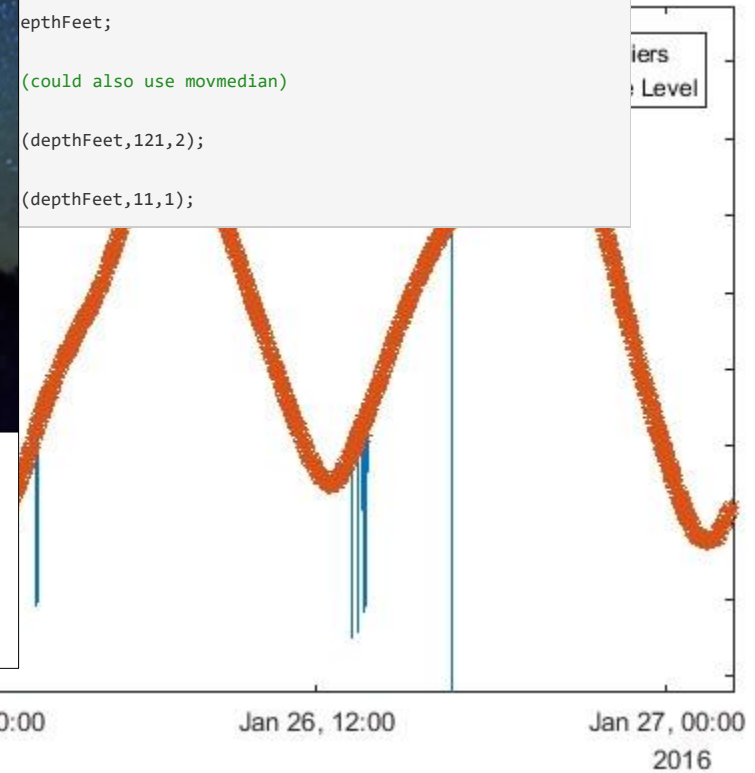

The end of slides!